

Mortice

Mortice Lock : 281a (Sash lock)

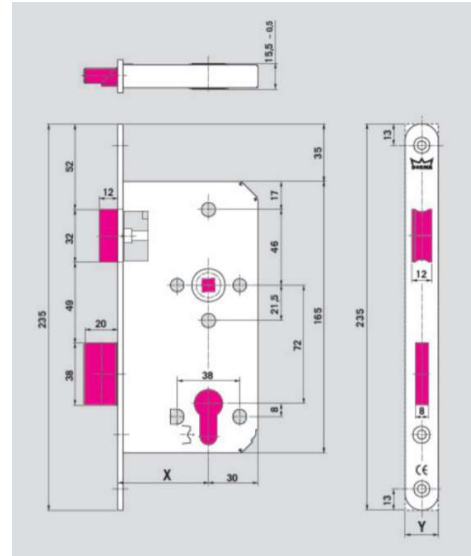

- Back set : 55 mm.
- Square Forend : L 235 x 24 mm.
- Finish : Satin Stainless Steel (SS304)
- Standard Certified : Grade 2 EN 12209 (200,000 cycles tested)
- Non-handed : Yes
- Certificate approved for fire door : Yes (CE Certificate – 4hrs. fire rated)



Mortice Lock : 271a (Single throw 15mm.)



- Back set : 55 mm.
- Square Forend : L 235 x 24 mm.
- Finish : Satin Stainless Steel (SS304)
- Standard Certified : Grade 2 EN 12209 (200,000 cycles tested)
- Non-handed : Yes
- Certificate approved for fire door : -

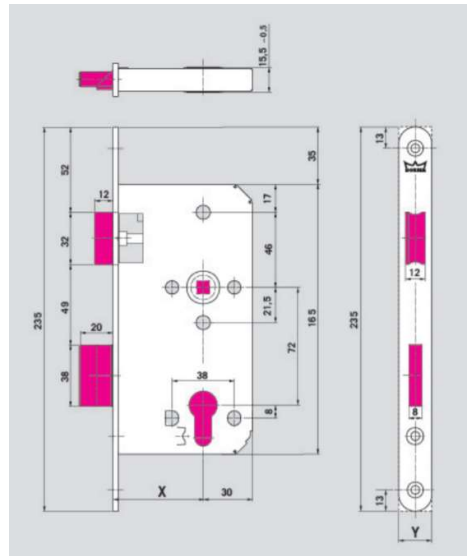

Mortice Lock : 208a (Small dead lock)



- Back set : 55 mm.
- Square Forend : L 138 x 24 mm.
- Finish : Satin Stainless Steel (SS304)
- Standard Certified : Grade 2 EN 12209 (200,000 cycles tested)
- Certificate approved for fire door : -

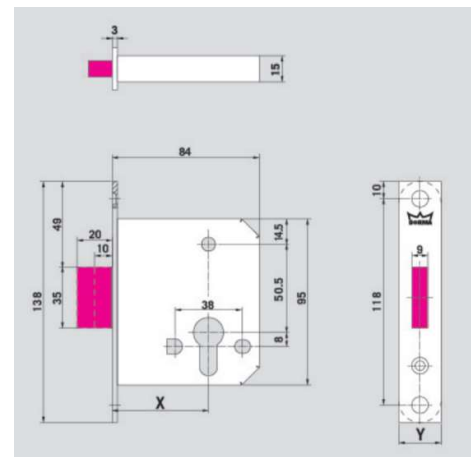

Mortice

Mortice Lock : 209a (Small latch lock)

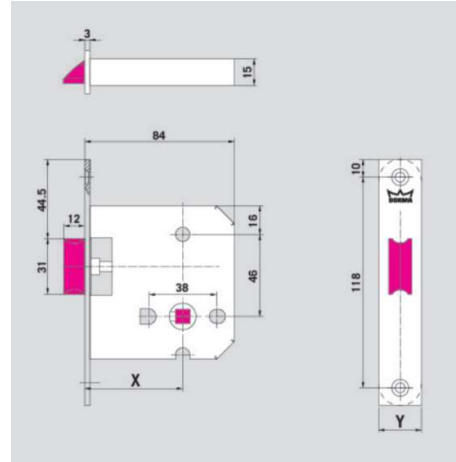

Back set : 55 mm.
 Square Forend : L 138 x 24 mm.
 Finish : Satin Stainless Steel (SS304)
 Standard Certified : Grade 2 EN 12209 (200,000 cycles tested)
 Certificate approved for fire door : -

Mortice Lock : A35ZD (Narrow-Stile dead lock)

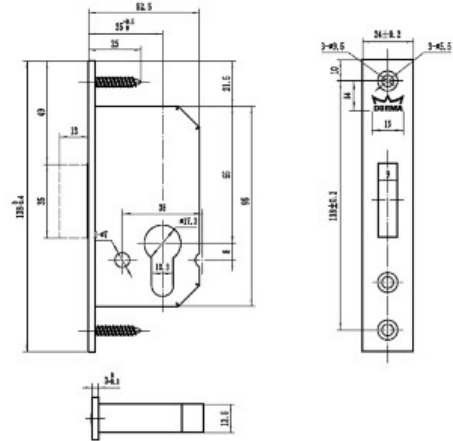

Back set : 35 mm.
 Square Forend : L 138 x 24 mm.
 Finish : Satin Stainless Steel (SS304)
 Standard Certified : Grade 2 EN 12209 (200,000 cycles tested)
 Certificate approved for fire door : -

Mortice Lock : 352a (Narrow-Stile sash lock)

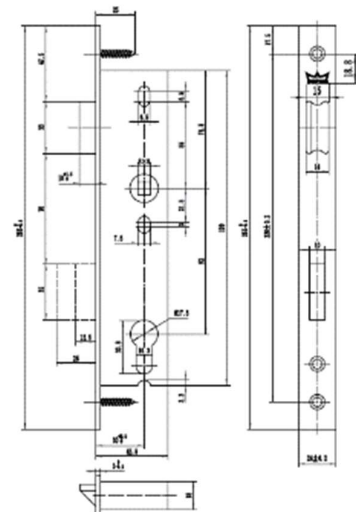

Back set : 30 mm.
 Square Forend : L 255 x 24 mm.
 Finish : Satin Stainless Steel (SS304)
 Standard Certified : Grade 2 EN 12209 (200,000 cycles tested)
 Non-handed : Yes
 Certificate approved for fire door : -

Mortice

Mortice Lock : 232a (Roller latch)



- Back set : 55 mm.
- Square Forend : L 235 x 24 mm.
- Finish : Satin Stainless Steel (SS304)
- Standard Certified : Grade 2 EN 12209 (200,000 cycles tested)
- Certificate approved for fire door : -

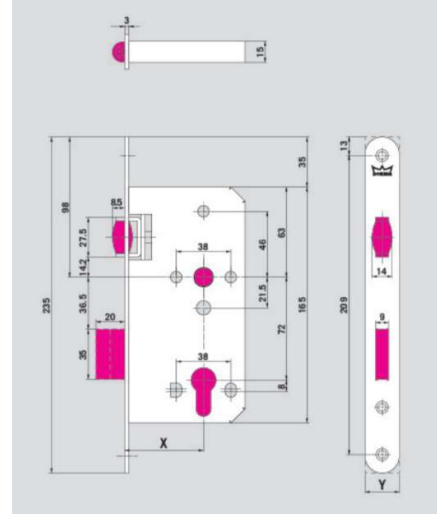

Mortice Lock : 393a (Classroom)



- Back set : 55 mm.
- Square Forend : L 235 x 24 mm.
- Finish : Satin Stainless Steel (SS316)
- Standard Certified : Grade 3 EN 12209 (200,000 cycles tested)
- Non-handed : LH or RH
- Certificate approved for fire door : Yes (CE Certificate – 4hrs. fire rated)

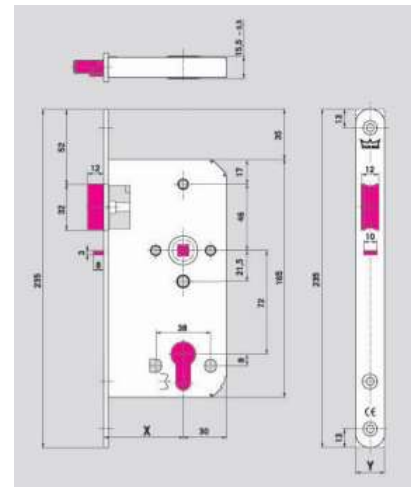

Mortice Lock : 381a (Sash lock)



- Back set : 55 mm.
- Square Forend : L 235 x 24 mm.
- Finish : Satin Stainless Steel (SS316)
- Standard Certified : Grade 3 EN 12209 (200,000 cycles tested)
- Non-handed : Yes
- Certificate approved for fire door : Yes (CE Certificate – 4hrs. fire rated)

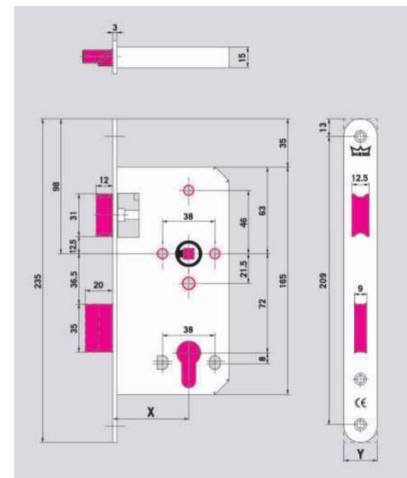

Mortice

Mortice Lock : 20HJ (Hook Lock)



- Back set : 20 mm.
- Square Forend : L 176 x 20 mm.
- Finish : Satin Stainless Steel (SS304)
- Standard Certified : -
- Non-handed : Yes
- Certificate approved for fire door : -

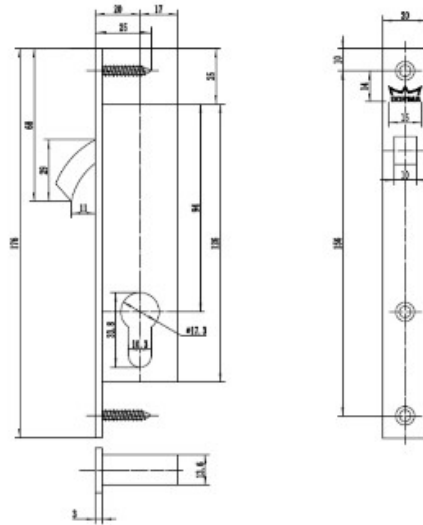

Mortice Lock : 30HJ (Hook Lock)



- Back set : 30 mm.
- Square Forend : L 176 x 20 mm.
- Finish : Satin Stainless Steel (SS304)
- Standard Certified : -
- Non-handed : Yes
- Certificate approved for fire door : -

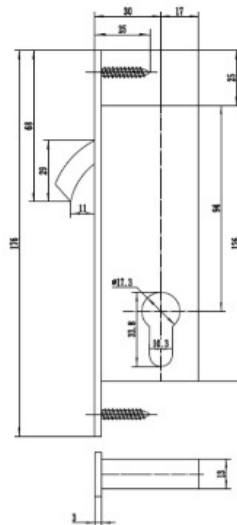

Mortice Lock : 60HJ (Hook Lock)



- Back set : 60 mm.
- Square Forend : L 158 x 20 mm.
- Finish : Satin Stainless Steel (SS304)
- Standard Certified : -
- Non-handed : Yes
- Certificate approved for fire door : -

